



祥能精機股份有限公司
Hsiang Neng DC Micro Motor Manufacturing Corp.



Sales@hsiangneng.com
04-8350536

www.hsiangneng.com

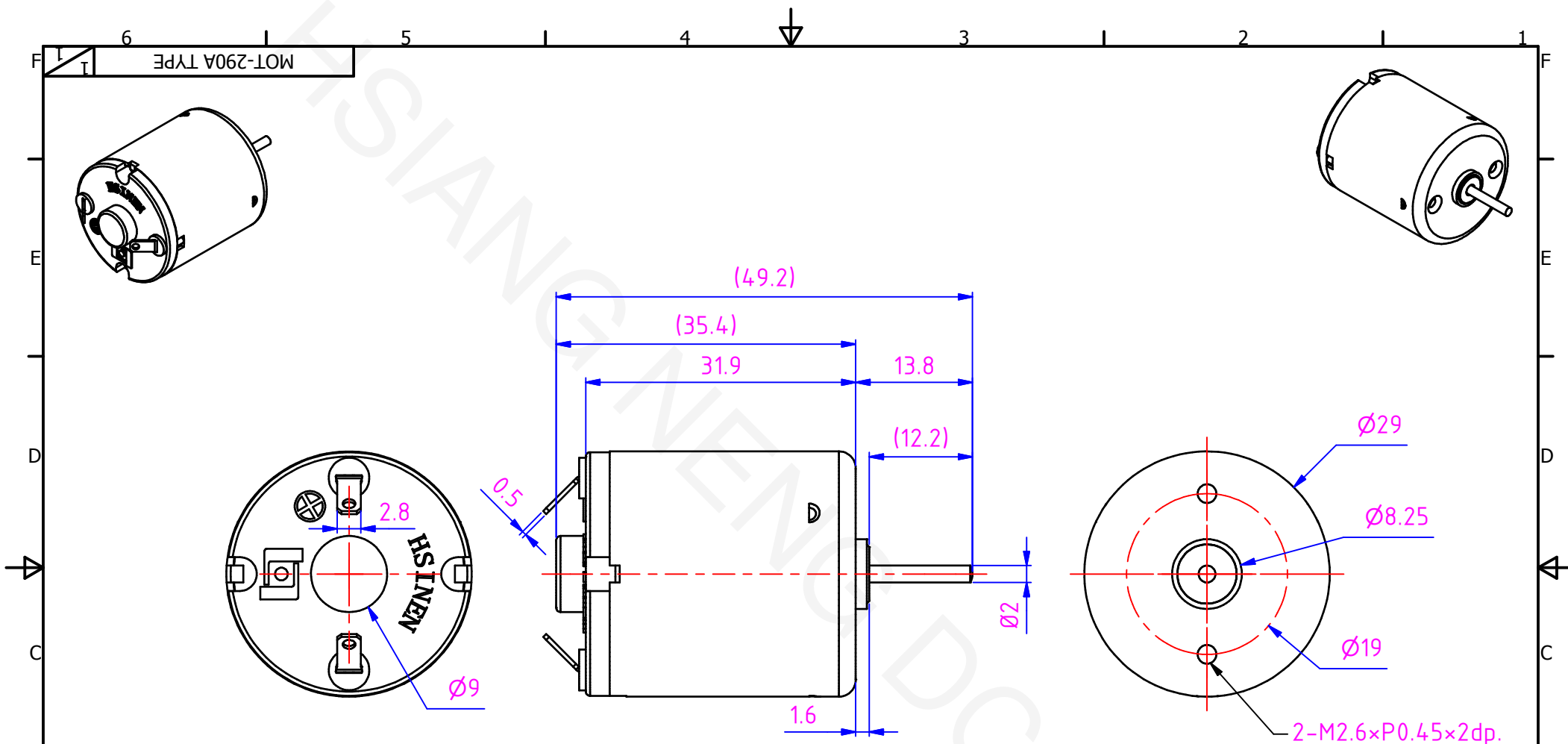

※HN290A TYPE

公差 ALLOWANCE	±0.5	圖號 DWG. NO.	MOT-290A TYPE	1/1	日期 DATE	2016.12.27
圖名 DESCRIPTION	馬達外觀圖	比例 SCALE	1.5 : 1	核准 APPROVED		
機型 MODEL	HN290 Series	材質 MATERIAL		核對 CHECKED BY		
客戶 CUSTOMER		單位 UNIT	mm[in]	繪圖 DRAWN BY	C.C.T.	

祥能精機股份有限公司
HSIANG NENG DC MOTOR
MANUFACTURING CORP.

更改紀錄
REVISIONS

版本
VERSION B-0